

SPECIFICATION

CTEZED 25 HV

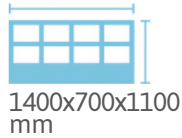

WORKING ENVELOPE

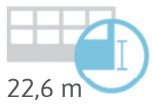
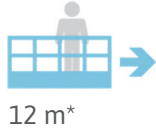
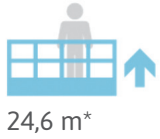
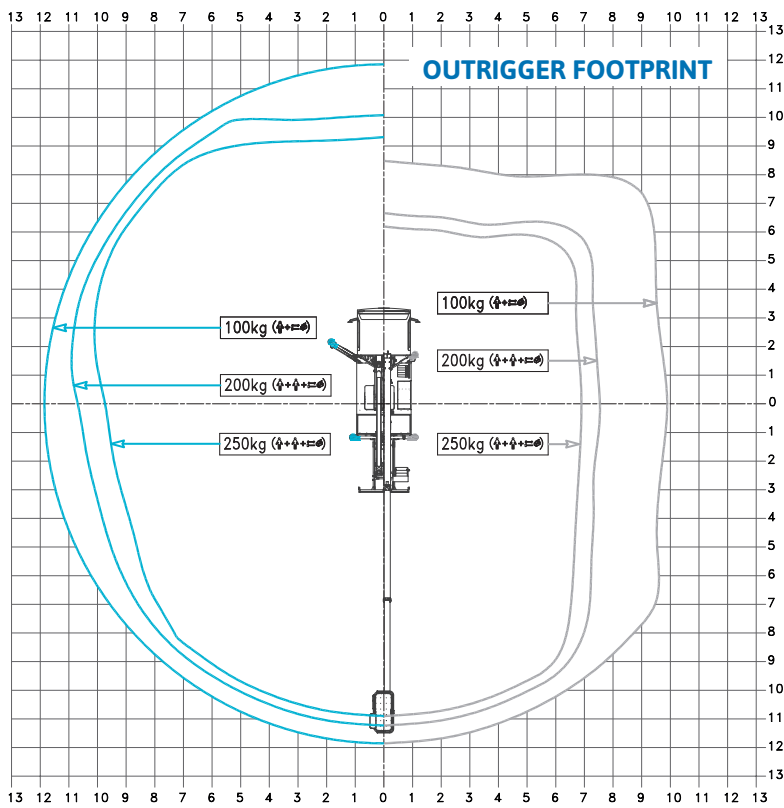
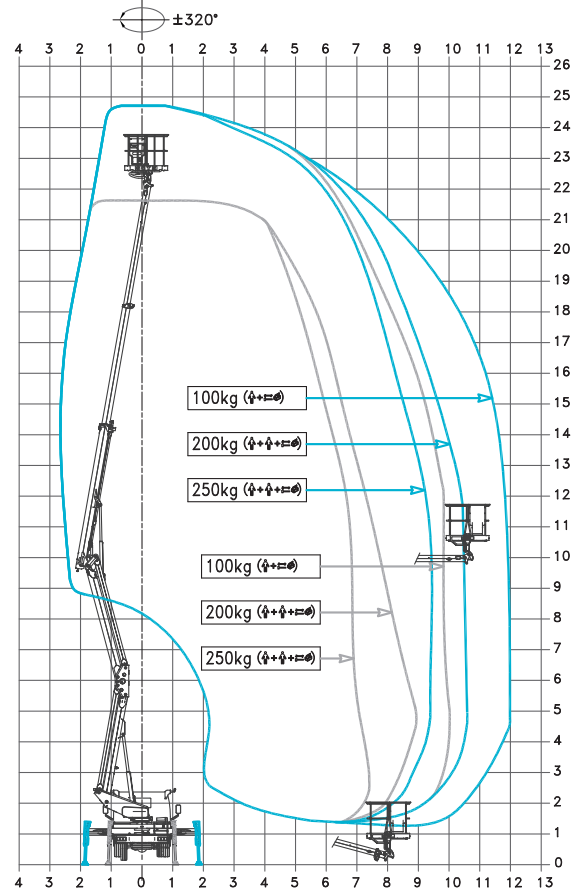

* outreach and height max values and repeatability can change within $\pm 3\%$ due to manufacturing variation and working condition.

DIMENSIONS

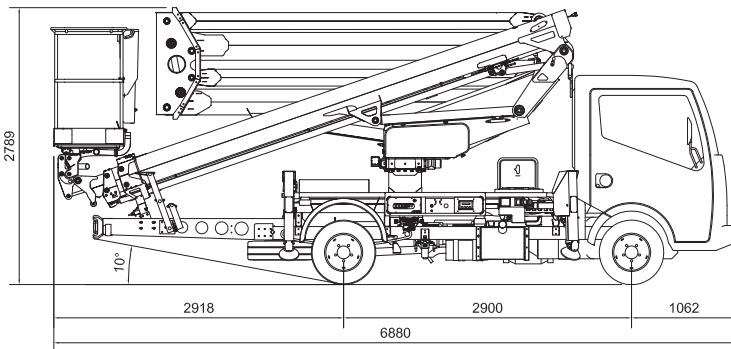
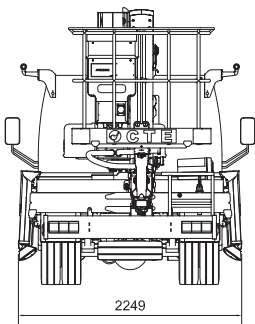

Product specifications are subject to change without notice or obligation. Technical features and drawings in this brochure are for illustrative purposes only. _ZED 25 - ed. 06/18



CTE S.p.A.

Headquarter 7 Via Caproni - Rovereto (TN) IT, 38068

Ph. +39 0464 48.50.50 - Fax +39 0464 48.50.99

info@ctelift.com - www.ctelift.com

Factory 5 Loc. Terramatta - Rivoli Veronese (VR) IT, 37010

CTE UK Ltd Enderby Leicestershire - UK

